

Twin Pole Lite

Cat. No. TPL

Cat. No. TPL/R



Two individual spotlights which can be aimed in two entirely different directions. Each lite has fully adjustable arms allowing 360 degree rotation and 0 - 90 degree elevation. The Twin Pole Lite is ideal for path lighting as well as tree lighting, or the heads may be aimed downward to eliminate vertical light.

The Retro™, which is a mains option, avoids the need to bury a transformer. The 240/12 volt electronic transformer is built into the pole and is a double insulated safety isolating transformer this changes the luminaire to an IP56 rating.

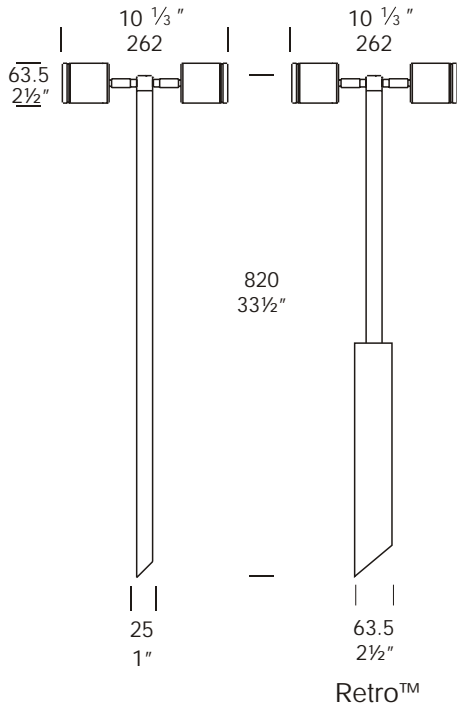

Ordering Information

Luminaire Type

TPL - Twin Pole Lite

Material/Finish

BK - Black
 BZ - Bronze
 GN - Green
 MS - Metallic Silver
 WH - White

COP - Copper
 SS - 316 Stainless Steel

Accessories

CJK150 - CJK150 Cable Joint Kit
 DFL - Frost Lens
 GG - Glare Guard
 HCL - Hex Cell Louvre Adaptor
 SSP/G - Hunza® Super Spike
 /R - Retro™ Transformer
 240/12 volt

Ordering Example: TPL SS - Twin Pole Lite in 316 Stainless Steel

TPL/R COP - Twin Pole Lite Retro™ in Copper

HCL - Hex Cell Louvre Adaptor
 (Accessories ordered separately)



Patent Pending



FACTORY: Ph: 64-9-528 9471 Fax: 64-9-528 9361.

USA: Ph. 310 560 7310 Fax. 1 877 692 4589.

hunza@hunza.co.nz www.hunza.co.nz

Specifications may change without notice.

130 Felton Matthew Ave, Glen Innes, Auckland, New Zealand.

3237 Long Island St, W. Sacramento, California 95691, USA.

Manufactured in New Zealand.

© 2003 Hunza Holdings Ltd

Luminaire Construction

CNC machined from one of the following metals:

High corrosion resistant 63.5mm (2½") x 10mm (25/64") aluminium.
End cap - solid aluminium 63.5mm (2½") rod, with chromate substrate and high UV resistant polyester powder coat - Colours Black, White, Bronze, Green, Metallic Silver.

Copper 63.5mm (2½") x 10mm (13/32"). End cap - solid copper 63.5mm (2½") rod.

Stainless steel 316 9mm (11/32"). End cap - solid 316 stainless steel 63.5mm (2½") rod.

Poles: Aluminium, Copper, 316 Stainless 25.4mm (1") x 850mm (33½") tube.

Retro™: Pole - 25.4mm (1") x 410mm (16") tube.

Transformer Pole 63.5mm (2½") x 440mm (17½").

Mounting

Pole 850mm (33½") directly mounted into the earth or for extra stability in sand or loose ground use a Hunza® Super Spike. Retro™ set in concrete.

Features

Lens:

3mm (1/8") clear tempered shatter resistant glass. Life Time Warranty.

Gaskets:

Silicone, iron impregnated 220°C (428°F).

Lamp Holders:

GU5.3 - 350°C (662°F) ceramic multi contact lamp holders with 250°C (480°F) teflon cables.

Accessories:

Cable Joint Kit (Cat. CJK 50).
Not approved for USA /Canada.

Frosted Lens (Cat. DFL).

Glare Guard (Cat. GG)

Hex Cell Louvre Adaptor (Cat. HCL)

Hunza® Super Spike, not suitable for Retro™ option (Cat. SSP/G).

Retro™ transformer 240/12 volt (Cat. /R) IP56.

Swivels:

Aluminium and Copper luminaires - 360° rotation and 0 - 90° elevation, solid brass with anti rust spring.

Stainless Steel luminaires - 360° rotation and 0 - 90° elevation, full stainless steel construction.

Standards

IP56 / IP66



UL1838

Luminaire Weight

12 volt Alum 1.180kg (2lb 9oz)
Cop 3.300kg (7lb 4oz)
SS 2.580kg (5lb 11oz)

Retro™ Alum 2.360kg (5lb 3oz)
Cop 4.300kg (9lb 7oz)
SS 3.800kg (8lb 6oz)

Power Supply

HUNZA® Inground or Wall Mount
Transformer: not included.

RETRO™ IP56

HUNZA® 240/12 volt ac silicone encapsulated electronic transformer is built into the pole. Dimmable with a suitable leading edge dimmer.

USA and Canada

HUNZA® Wall Mount Transformer: not included.

Luminaire: supplied with

MR16 GU5.3 2 x 20, 35, 50 watt lamps max.
Retro™ MR16 GU5.3 2 x 20 watt lamps max.

USA and Canada

MR16 GU5.3 2 x 20 watt lamps.
When glare guards fitted lamp wattage can be increased to 35 watt.

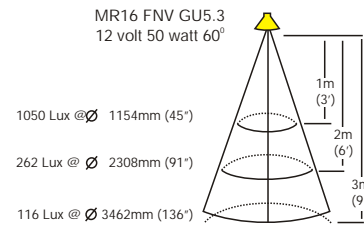
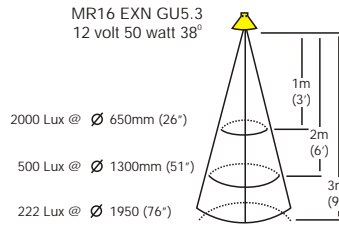
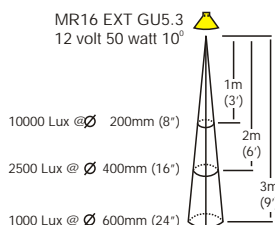
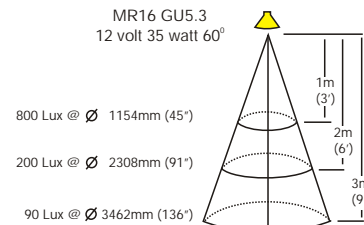
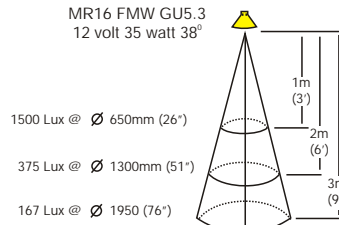
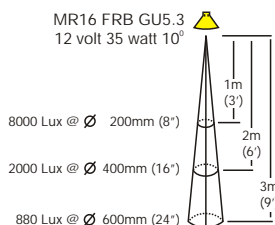
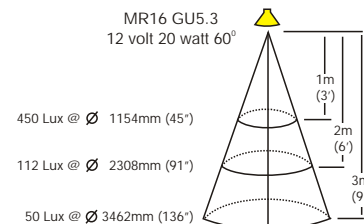
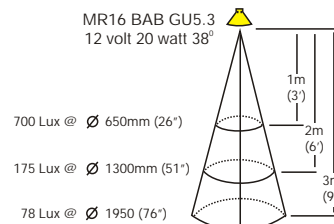
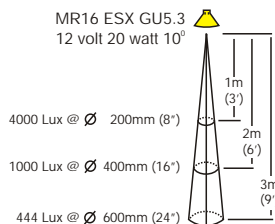

FACTORY: Ph: 64-9-528 9471 Fax: 64-9-528 9361.
USA: Ph. 310 560 7310 Fax. 1 877 692 4589.
hunza@hunza.co.nz www.hunza.co.nz
Specifications may change without notice.

130 Felton Matthew Ave, Glen Innes, Auckland, New Zealand.
3237 Long Island St, W. Sacramento, California 95691, USA.
Manufactured in New Zealand.

© 2003 Hunza Holdings Ltd