

# Pond Lite

Cat. No. Pond

Cat. No. Pond/W



The Pond Lite is fully submersible and is adjustable on two planes. A version with a weighted base is available, allowing the luminaire to be placed in the pond without drilling fixing holes to mount it. It is supplied with a 3 metre (9') submersible cable.

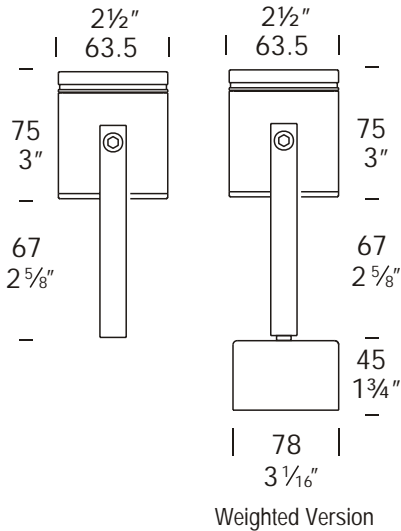

## Ordering Information



### Luminaire Type

POND - Pond Lite

### Material/Finish

- BK - Black
- BZ - Bronze
- GN - Green
- MS - Metallic Silver
- WH - White
  
- COP - Copper
- SS - 316 Stainless Steel

### Accessories

- CJK150 - Cable Joint Kit
- DFL - Frosted Lens
- GG - Glare Guard
- HCL - Hex Cell Louvre Adaptor
- LED - LED Array
- /W - Weighted Base

Ordering Example POND/W COP - Pond Lite Weighted Version in Copper

HCL SS - Hex Cell Louvre Adaptor in 316 Stainless Steel  
(Accessories ordered separately)

Patent Pending



FACTORY: Ph: 64-9-528 9471 Fax: 64-9-528 9361.  
 USA: Ph. 310 560 7310 Fax. 1 877 692 4589.  
 hunza@hunza.co.nz www.hunza.co.nz  
 Specifications may change without notice.

130 Felton Matthew Ave, Glen Innes, Auckland, New Zealand.  
 3237 Long Island St, W. Sacramento, California 95691, USA.  
 Manufactured in New Zealand.

© 2003 Hunza Holdings Ltd

## Luminaire Construction

CNC machined from one of the following metals:

High corrosion resistant 63.5mm (2½") x 10mm (25/64") aluminium.  
End cap - solid aluminium 63.5mm (2½") rod, with chromate substrate and high UV resistant polyester powder coat -

Colours Black, Bronze, Green, Metallic Silver, White.

USA /Canada:  
Aluminium is not approved.

Copper 63.5mm (2½") x 10.5mm (13/32"). End cap - solid copper 63.5mm (2½") rod.

Stainless steel 316 9mm (11/32"). End cap - solid 316 stainless steel 63.5mm (2½") rod.

## Mounting

Via a "U" bracket that is screwed to the mounting surface. If being used in a pond with a plastic liner then the weighted version should be used. No screws are required for fixing, therefore no leaks.

Note: Copper may not be suitable for use with fish.

## Features

### Lens:

3mm (1/8") thick clear tempered shatter resistant glass.

Life Time Warranty.

### Gaskets:

Silicone, iron impregnated 220°C (428°F).

### Lamp Holder:

GU5.3 - 350°C (662°F) ceramic multi contact lamp holder with 250°C (480°F) teflon cables.

### Cable:

1.3mm (16AWG) 3 metre (9') submersible cable, longer cable available on request..

### Accessories:

Cable Joint Kit (Cat. CJK 50)  
Not approved for USA /Canada.

Frosted Lens (Cat. DFL).

Glare Guard (Cat GG).Hex Cell

Louvre Adaptor (Cat. HCL).

LED Array (Cat. LED). Red, Green, Blue, Yellow and White.

Weighted Base (Cat. W)

## Standards

IP68



UL676

### Luminaire Weight (including cable)

Alum .740kg (1lb 11oz)  
Cop 1.50kg (3lb 4oz)  
SS 1.30kg (2lb 13oz)

### Weighted Version

Alum 1.165 (2lb 9oz)  
Cop 2.050 (4lb 6oz)  
SS 1.880 (4lb 2oz)

### Power Supply

HUNZA® Inground or Wall Mount Transformer: not included.

HUNZA® H20/24LED: not included.

HUNZA® IG20/24LED: not included.

### USA and Canada:

Ground shielded earth transformer: not included.

### Luminaire: supplied with

MR16 GU5.3 20, 35, 50watt max.  
LED Array 24 volt d.c. 1.2 watt.

### USA and Canada:

MR16 GU5.3 20, 35, 50 watt max.  
LED Array 24 volt d.c. 1.2 watt.

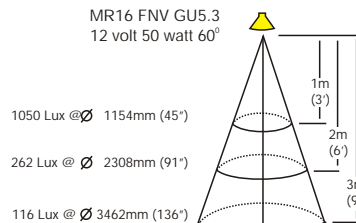
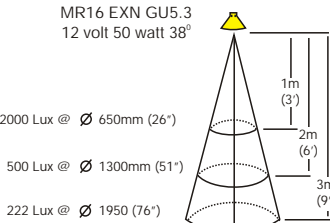
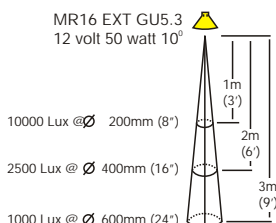
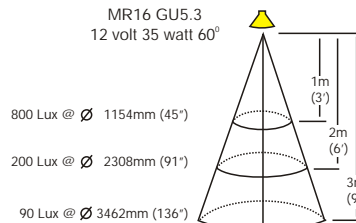
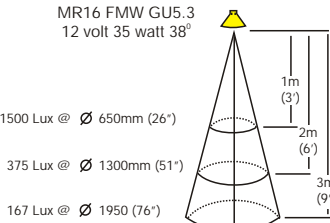
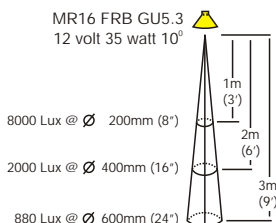
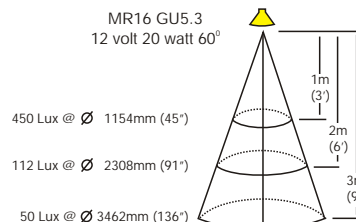
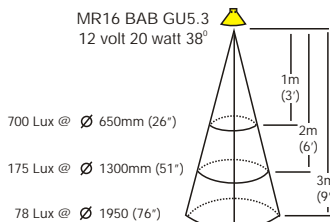
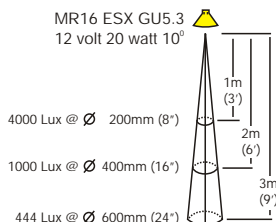

FACTORY: Ph: 64-9-528 9471 Fax: 64-9-528 9361.  
USA: Ph. 310 560 7310 Fax. 1 877 692 4589.  
hunza@hunza.co.nz www.hunza.co.nz  
Specifications may change without notice.

130 Felton Matthew Ave, Glen Innes, Auckland, New Zealand.  
3237 Long Island St, W. Sacramento, California 95691, USA.  
Manufactured in New Zealand.

© 2003 Hunza Holdings Ltd